

Yamada

INSTRUCTION

OIL PUMP

DR-50A1 (DRUM TYPE)

MODEL No.852958

SH-50A1 (SIPHON TYPE)

MODEL No.852960

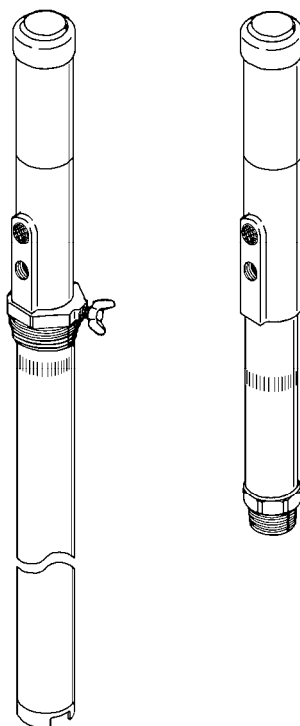

WARNING

Prior to operating this pump, be sure to read this operation manual for safety. After reading the manual, please keep it at hand any time for your quick reference.

YAMADA CORPORATION

- Preface

Thank you very much for purchasing Yamada Pump. This pump, driven by the compressed air from an air compressor, is designed to pump out or transfer lubricant from drum cans or other vessels. The material of the liquid contact section of the machine is aluminum alloy (A6061 - T6), and that of the seal section is NBR. Any solvent which does not agree to these materials is not available.

- For Safe Operation

This manual describes the items that are important for the user to operate this product safely, correctly, and efficiently. Before operating this product, read this manual thoroughly, in particular, "Warnings and Cautions" at the beginning of this manual.

- Warnings and Cautions

For safe use of this product, be sure to note the following: In this document, warnings and cautions are indicated by symbols. These symbols are for those who will operate this product and for those who will be nearby, for safe operation and for prevention of personal injury and property damage. The following warning and caution symbols have the meanings described below. Be sure to remember their meanings.



WARNING : This indicates the existence of potential hazard which, if not avoided, will result in death or serious injury.



CAUTION : This indicates the existence of potential hazard which, if not avoided, may result in bodily injury or in physical damage.

Furthermore, to indicate the type of danger and damage, the following symbols are also used along with those mentioned above:



















This symbol indicates an act that is prohibited (prohibition). The concrete contents of prohibition are indicated by the side of the indication.



This symbol indicates the contents that must be observed. The concrete contents of observance are indicated by the side of the indication.

- Precautions on Use

The following warnings and cautions are very important. Be sure to observe them.

 WARNING	
	- Keep your face away from the exhaust and discharge ports. Material may suddenly come out. There is a possibility of losing eyesight if it strikes eyes.
	- Gasoline is a high volatile fuel. Do not use it to clean the pump in any case, otherwise ignition or explosion may be caused.
	- Keep your fingers away from each port to avoid injury from moving parts.
	- Modification of this pump may lead to death, bodily injury, or a failure. Do not modify it in any case because it involves a risk.
	- The operator and maintenance engineer should read the operation manual thoroughly before operating the pump and performing maintenance in respect of this pump.
	- Always wear proper safety equipments(facemask, ear plugs, and safety shoes, etc.) when installing, operating and disassembling the pump.
	- Make ground connection when working with flammable material or in explosive atmosphere. Rapid pumping of material can result in static electrical charge. Also, be sure to provide proper ventilation where a flammable atmosphere may exist.
	- Execute the daily checkup.
	- Use this pump according to the product specification.
	- Attach a valve(for stop in emergency) or regulator to the air supply pipe to keep supply air pressure under 0.7 MPa.
	- Discontinue it when you feel a hazard or abnormality during the work. And correspond according to the troubleshooting.
	- Stop pump operation immediately when a drum becomes empty. Running the pump dry will cause excessive vibration, resulting in reduction of pump life and damage to other equipment. Be especially careful when pumping explosive material. Mixture of an air and vaporized material can explode. If there is any possibility of running dry, install a dry-run protection device like a liquid level control.
	- Before maintenance operation, be sure to stop air from being supplied to the pump, and release the internal pressure (both air and material) of the pump. There is danger such as spouting of the material when the maintenance work is done with air supplied.
	- Do not discharge material directly onto the ground. Dispose of harmful materials according to the requirements specified in MSDS or local regulations. Also, dispose of pump according to the local regulations after removing residual material from inside pump. (Please contact industrial waste disposal service.)
	- (SH type only)If using a wall mount bracket for installation, the wall must be strong enough to withstand vibration of the pump.



CAUTION



- Keep hands and fingers away from the pump during operation to avoid injury from moving parts.



- Use pump for the material suitable for the specification. Parts may be corroded and material leak from the damaged parts can lead to environmental pollution. Also, follow handling notes (MSDS) of the manufacturer about the handling of the material used.



- Take fall-prevention measures if using a slim or light tank. Risk of falling will be increased due to shift in center of gravity caused by change in the material level in a tank.



- Take protective measures against rainwater and dust. It is likely to lead to the pollution of the material.



- Be very careful about the edge of the pump when you lift the pump. Your hands might be injured.



- Be very careful about your posture when installing the pump. Back injury may be caused by lifting the pump.



- Do not touch the surfaces of the pump and the hose when pumping high-temperature material. Risk of burns exists.



- Stop the air supply source after the end of work when not using this pump for a long time such as nighntimes and holidays. Also, open the valve of the exhalation port and liberate pressure in the pump and the hose. There is a possibility of polluting facilities because of the damage of the hose and the leakage of the valve. Such a secondary disaster becomes a responsibility on the user side.



- (DR type only)Place a drum on a flat, level surface to position pump horizontally against a ground. Operating the pump on a slope may cause a fall or tip-over due to shift in center of gravity caused by change in the material level.



- (DR type only)Material remaining inside or on the surface of the pump may spill out by inserting or removing the pump into/from a drum. Be very careful not to get your clothing dirty.

Table of Contents

- Preface
- For Safe Operation
- Warnings and Cautions
- Precautions on Use
- 1. Names and Materials of Parts**
 - 1.1 Names and Materials of Parts 1
 - 1.2 Contents of Package 1
- 2. Principle of Operation** 1
- 3. Installation**
 - 3.1 For the Drum Pump 1
 - 3.2 For the Siphon Pump 2
- 4. Air Connection** 3
- 5. Operating Method** 3
- 6. Maintenance and Inspection**
 - 6.1 Troubleshooting and Corrective Measures 4
 - 6.2 Maintenance and Inspection 4
- 7. Disassembly and Assembly** 5
- 8. Parts Disassembly Drawing and Parts List** 6
- 9. Pump Specifications** 7
- 10. Accessory for SH-50A (852960)** 8
- 11. Limited Warranty** 9

1. Names and Materials of Parts

1.1 Names and Materials of Parts

[Drum pump]

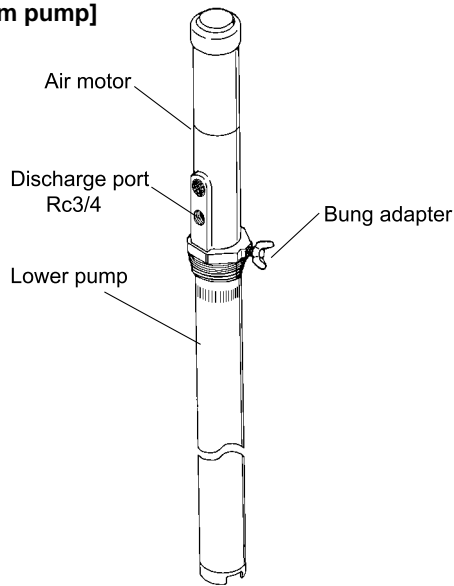

[Siphon pump]

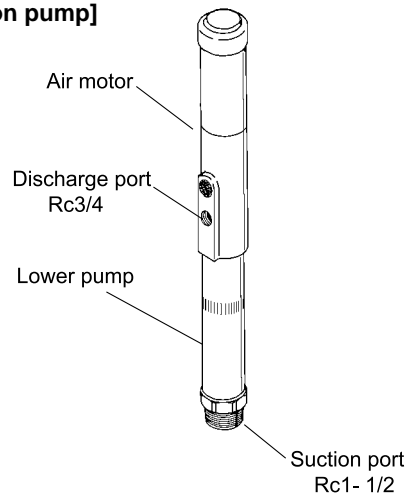

1.2 Contents of Package

This machine is packaged in a corrugated fiberboard case. Open the top lid of the corrugated fiberboard case and check the machine for damage.

2. Principle of Operation (Fig. 1)

The Yamada air-powered pump is a reciprocating type pump that is driven by compressed air. The pump consists of an air motor section to drive the pump and a lower pump to pump up the material as shown in the Fig. 1 at right.

When the compressor feeds compressed air to the air motor, the air piston starts up/down reciprocating motion by means of the function of the built-in air changeover mechanism.

This function is transmitted to the piston of the lower pump by the connecting rod that connects the air piston of the air motor to the piston of the lower pump, and gives up/down reciprocating motion to it.

The material is pumped into the lower pump by the up/down reciprocating motion of the piston of the lower pump and discharged by pressure from the discharge port.

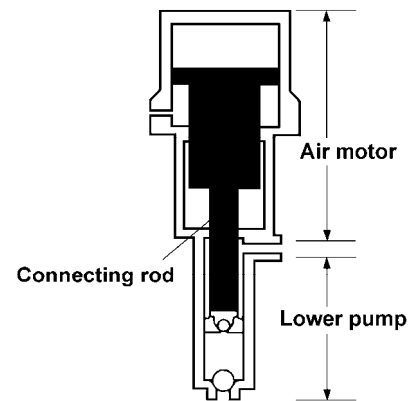

Fig. 1

3. Installation

3.1 For the Drum Pump

- 1) Unpack and take out the pump.
- 2) Fix the pump with a vise and connect a prepared material hose to its discharge port. When this is done, it is recommended to purchase and attach a hose union to between the pump and hose. (Fig. 2)
- 3) Unplug the inlet port (2") of the drum can and screw in the bung adapter connected to the pump. (Fig. 3)

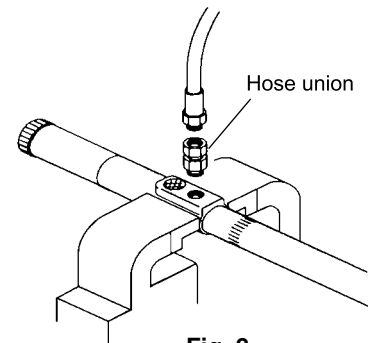

Fig. 2

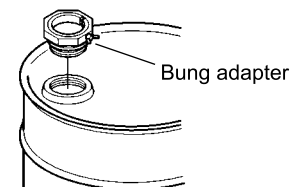



Fig. 3

- 4) Insert the pump into the bung adapter. After the lower end of the pump (foot valve section) hits the bottom of the drum, lift the pump by 2 to 3 cm to secure a gap between the bottom of the drum and the foot valve. After determining a position, tighten a wing bolt of the bung adapter to fix the pump. (Fig. 4)

<Note>

- The procedure is also available for resin type drums. Screw in the upper screw of the bung adapter into the drum.

	CAUTION
	- When using a covered vessel such as a drum can, be sure to loosen a vent plug so that the inside of the vessel will not be evacuated.

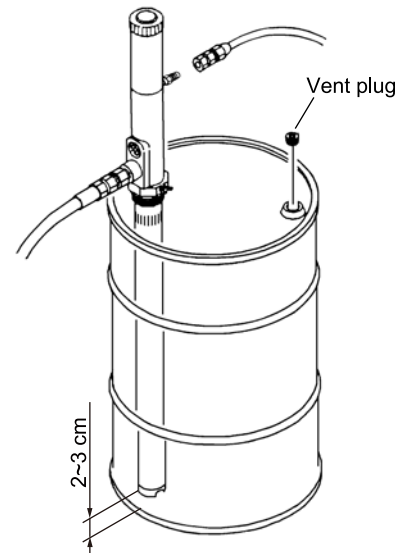

Fig. 4

3.2 For the Siphon Pump

- 1) Loosen the bolts of the pump fixing band for the mounting bracket (option, product number 800400) to remove the band. Set the pump onto the bracket, support with the pump fixing band, and fix with accessory bolts. When this is done, tighten the bolts to such an extent that the pump will not rotate. (The tightening torque is 12N-m or less.) If tightened too much, the plunger in the suction tube will not work. (Fig. 5)
- 2) Connect the R1-1/2 inch at the hose inlet port of the suction hose assembly (option, product number 850126) to the suction port of the pump. When this is done, wind commercially available sealing tape around the male screw of the pump and screw it in.
- 3) Unplug the drum can (2B) and screw the bung adapter attached to the suction hose assembly into an unplugged hole and insert the suction tube. In the same manner as in 3.1-4), adjust a gap between the bottom of the drum and the suction port of the suction tube.

<Note>

- The material hose used should have pressure resistance of 1 MPa or more and be oil resistant. When an adequate hose is not available, place an order with our dealer for a special purpose hose by the following production number.

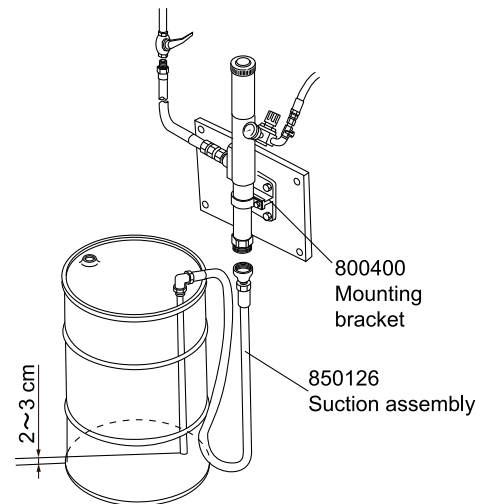



Fig. 5

	CAUTION
	[Precaution for installation] - Do not directly connect the piping to the pump. Direct connection damages the piping by vibrations when running the pump, causes noises, and in case of the drum pump, makes it impossible to replace the drum can and disables maintenance of the pump. (Fig. 6)

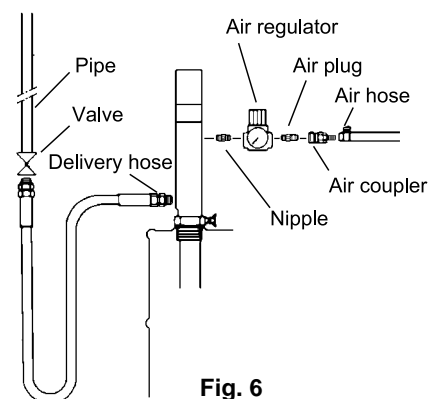

Fig. 6

- Be sure to use a flexible hose to connect between the pump and piping.

4. Air Connection

- 1) Attach an air regulator (option) to the air supply port of the pump. A special purpose air regulator is optionally provided for your use.
- 2) Connect an air hose from the air piping and connect to the IN side of the pump via the air regulator.



CAUTION



- In order to use the pump safely and enjoy a long service life, be sure to attach the air regulator to the air supply port. (The air regulator consists of a reducing valve and pressure gauge.)

<Notes>

- If the air has been supplied to the air hose, the pump will be activated the moment it is connected. Prior to connecting the air hose to the pump, be sure to turn the knob of the air regulator in the counterclockwise direction.
- Use of the air regulator allows you to adjust a supply air pressure to the pump, improve operability by reducing wasteful movements of the pump, thus prolonging the service life of the pump.
- The air pressure is increased by turning the knob in the clockwise direction and decreased by turning it in the counterclockwise direction.



CAUTION



- The supply air pressure to the pump should be 0.7 MPa or less. Do not raise the pressure over 0.7 MPa in any case.



- If the air supplied to the pump is not shut off after completion of the work or at night, the hose may be damaged or leak may occur on the valve or gun, thereby causing a secondary accident. This secondary accident shall be attributable the user's responsibility.

<Notes>

- The distance for pressure feed differs depending on the viscosity, temperature, and required flow rate of oil. Regarding details, please ask YAMADA CORPORATION or the dealer for further information.
- If the oil in the drum can has been exhausted, the pump is operated at a higher speed without oil and has an adverse effect on its life. Stop the pump operation at once and replace the drum can with a new one. For replacing the drum can, observe the item pertaining to <3.1 For the Drum Pump>.

5. Operating Method

- 1) Turn the knob of the air regulator in the clockwise direction to supply the air into the pump.
- 2) If the air is supplied, the pump will be activated for a while, fill the hose and gun with the oil, and stop.
- 3) The oil is discharged by operating the lever of the gun at the end of the material hose. Pulling the lever opens the valve and automatically activates the pump to discharge the oil. Returning the lever closes the valve and stops a discharge and the pump itself simultaneously.
- 4) Adjust the supply air pressure in accordance with the purpose of use. Normally, run the pump at the supply air pressure of 0.3 to 0.5 MPa. When using the pump to feed-pressure the oil, a discharge rate differs depending on the piping distance. Adjust the supply air pressure (up to 0.7 MPa) until your desired discharge rate is obtained.

<Note>

- When activation of the pump does not stop for a long period time, there may be a leak due to loose connection of the hose, piping, gun, etc. or idling due to worn piston packing or valve seat inside the lower pump. Stop an air supply and check.

6. Maintenance and Inspection

6.1 Troubleshooting and Corrective Measures

Symptom	Contents of inspection	Corrective measure
<ul style="list-style-type: none"> The pump fails to start. 	<ul style="list-style-type: none"> Whether or not the air is properly supplied. Whether or not the valve halfway the piping is closed <p style="text-align: center;">↓</p> <p>(Remove the material hose from the outlet port on the pump side and activate the pump.)</p> <ul style="list-style-type: none"> If activated, the material hose, piping or plumbing is clogged or an operating pressure is low. If not activated, the pump is out of order. <p style="text-align: center;">↓</p> <p>(Separate the lower pump and activate only the air motor.)</p> <ul style="list-style-type: none"> If activated, the lower pump is out of order. If not activated, the air motor is out of order. 	<ul style="list-style-type: none"> → Pressure check. (0.3 to 0.7 MPa) → Ask for service. → Ask for service.
<ul style="list-style-type: none"> The pump fails to stop. 	<ul style="list-style-type: none"> Whether or not there is a leak from the outlet valve (gun). Whether or not there is a leak from a joint of the piping, material hose, etc. Whether or not the drum is running out of the oil. <p style="text-align: center;">↓</p> <ul style="list-style-type: none"> The lower pump is out of order. 	<ul style="list-style-type: none"> → Replenish or replace → Ask for service.
<ul style="list-style-type: none"> The pump is operated but does not feed the material by pressure. 	<ul style="list-style-type: none"> Whether or not the drum is running out of the oil. <p style="text-align: center;">↓</p> <ul style="list-style-type: none"> The lower pump is out of order. 	<ul style="list-style-type: none"> → Replenish or replace → Ask for service.
<ul style="list-style-type: none"> The pump is operated but the pressure and flow rate are insufficient. 	<ul style="list-style-type: none"> Whether or not the supply air pressure has dropped. <p style="text-align: center;">↓</p> <ul style="list-style-type: none"> The lower pump is out of order. (Worn valve seat, clogging by dust) 	<ul style="list-style-type: none"> → Adjust the pressure. (Up to 0.7 MPa) → Ask for service.

6.2 Maintenance and Inspection





Cycle	Maintenance and inspection
Daily	① Check the following operating conditions. <ul style="list-style-type: none"> Pump is running smoothly as usual. There is no air leak or liquid leak from pump parts or piping. Abnormal noise is not heard. There is no damage to pump parts or piping.
Weekly	② Lubrication <ul style="list-style-type: none"> Lubricant oil: Turbine oil class 1 ISO VG32 How to lubricate. <ul style="list-style-type: none"> «Pump without a lubricator» <ul style="list-style-type: none"> Disconnect pipe from air supply port and directly apply a few drops (0.5 mL) of lubricant. «Pump equipped with a lubricator» <ul style="list-style-type: none"> Check the amount of oil in a lubricator and refill it. ※Be sure to shut off air supply before lubrication.
Yearly	③ Check for loose joint parts. <ul style="list-style-type: none"> Stop pump operation and shut off air supply. Then, check if any of threaded parts visible from the outside from pump will not be loosened by hand.
Triennially	④ Pump overhaul. <ul style="list-style-type: none"> Pump should be overhauled triennially. Depending on use frequency or degree of abrasion, pump may need to be overhauled earlier. Contact our dealer or business office for overhauling.

[Inspection]

The packing and slide portion parts of the pump are worn away. Check and replace them once a year.

7. Disassembly and Assembly

- When the pump does not function properly or stop, do not hasten to disassemble it. Seeing <6. Maintenance and Inspection>, scrutinize the condition and do not disassemble unnecessary parts.
- The air motor does not come into direct contact with the material and hardly goes out of order. You do not have to disassemble it. If disassembly is required by any chance, contact our service shop.

 <h3 style="margin: 0;">CAUTION</h3>	
	- Gasoline is a high volatile fuel. Do not use it to clean the pump in any case, otherwise ignition or explosion may be caused.
	- When cleaning pump parts, do not use a liquid that may corrode aluminum, copper ally, iron, etc.
	- Before disassembling and inspecting the machine, be sure to stop the supply air and open the outlet valve to release the internal pressure of the pump.

[Disassembling the Air motor and Lower pump]

- 1) Disconnect an air connection from the pump, turn off an air supply to the pump, and release the internal pressure of the pump.
- 2) Detach the air hose. If connected by piping, tighten a ball valve between the piping and material hose to prevent counterflow of the oil, and disconnect the material hose.
- 3) Draw out the pump from the drum can and drain the oil from inside the pump.
- 4) The oil can be drained by pushing open the foot valve section inside, using a screwdriver, etc. (Fig. 7)
- 5) Fix the pump body with a vise. (Fig. 8)

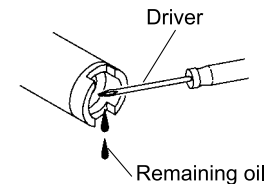

Fig. 7

<Notes>

- The cylinder made of aluminum alloy is vulnerable. Be sure to fix the main body with the vise.

- 6) By using a pipe wrench on the knurled of the tube. Unscrew the outer tube to take it off from the main body.
- 7) Remove an O ring from the plunger section, take out a pin, and pull out a connecting rod. (Fig. 8)

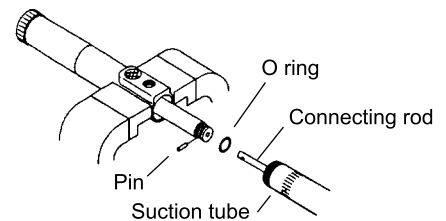

Fig. 8

[Disassembling the lower pump]

- 8) Pull out the piston valve from the suction tube.

<Notes>

- Take care not to cause the oil remaining in the tube to flow on the floor.

- 9) Fix the connecting rod with the vice and unscrew a nut to remove the valve body and valve seat. (Fig. 9)
- 10) Visually check the lip section of the packing inserted into the intake valve and replace it if it is worn out or scratched. (Fig.10)
(When replacing the packing, make sure that the open end of the lip faces upward.)
- 11) For assembling, reverse the disassembling procedure.

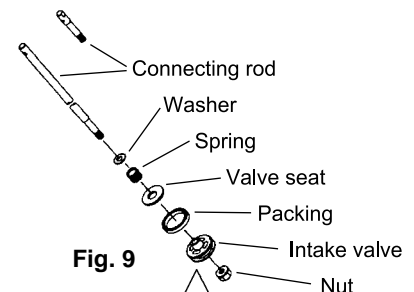

Fig. 9

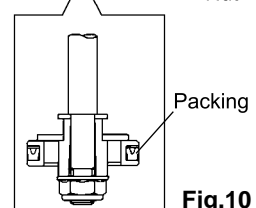

Fig.10

8. Parts Disassembly Drawing and Parts List

■ 852958 DR-50A1, 852960 SH-50A1

- Parts List

No.	Parts No.		Descriptions	Q'ty
	DR-50A1	SH-50A1		
①	803483	←	Air motor	1
②	803485	803487	Lower pump	1
③	803488	←	Bung adapter	1

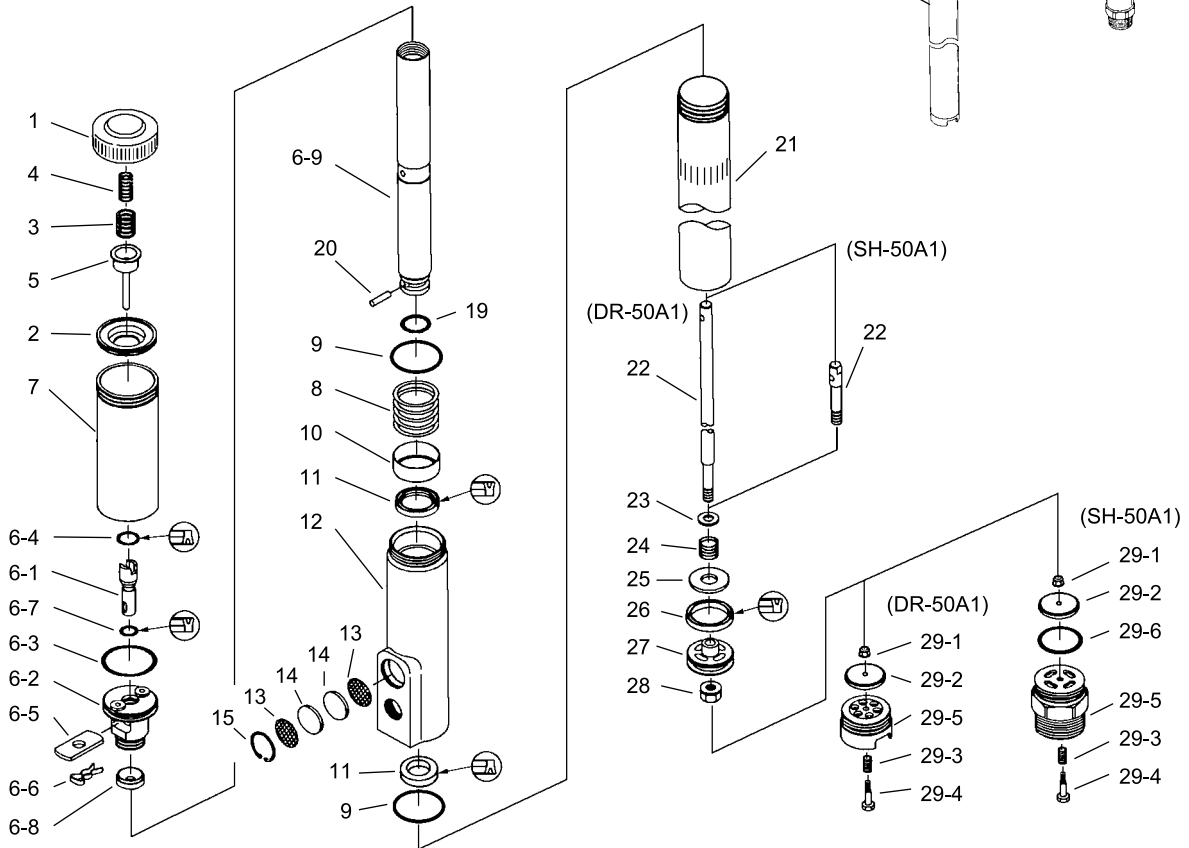
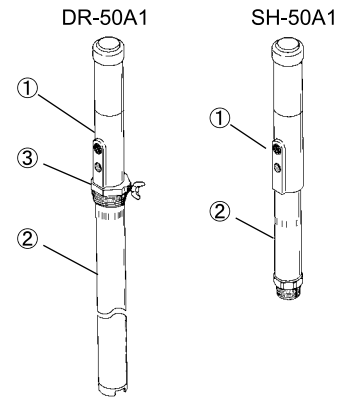

No.	Parts No.		Descriptions	Q'ty
	DR-50A1	SH-50A1		
1	705194	←	Cap	1
2	795092	←	Case housing	1
3	712906	←	Spring	1
4	712907	←	Spring	1
5	832119	←	Spring case assembly	1
6	803482	←	Piston assembly	1
6-1	712910	←	Valve	1
6-2	795093	←	Piston	1
6-3	640043	←	O ring	1
6-4	685173	←	U packing	1
6-5	712912	←	Valve plate	1
6-6	712913	←	Snap pin	1
6-7	683011	←	U packing	1
6-8	771960	←	Packing	1
6-9	712915	←	Plunger	1
7	712914	←	Air cylinder	1
8	712916	←	Spring	1
9	640135	←	O ring	2
10	771961	←	Spring holder	1
11	685274	←	Packing	2
12	712917	←	Body	1

No.	Parts No.		Descriptions	Q'ty
	DR-50A1	SH-50A1		
13	710613	←	Plate	2
14	771364	←	Muffler	2
15	630611	←	Retaining ring	1
19	640021	←	O ring	1
20	632581	←	Pin	1
21	712923	712926	Suction tube	1
22	712922	712925	Connecting rod	1
23	631210	←	Washer	1
24	712918	←	Spring	1
25	712919	←	Valve seat	1
26	684081	←	Packing	1
27	712920	←	Intake valve body	1
28	683270	←	Nut	1
29	803484	803486	Foot valve assembly	1
29-1	683502	←	Nut	1
29-2	705457	←	Valve plate	1
29-3	703219	←	Spring	1
29-4	712921	←	Bolt	1
29-5	712924	712927	Adapter	1
29-6	←	683440	O ring	1

9. Pump specifications

■ Engineering Data

TYPE		DR-50A1	SH-50A1
MODEL No.		852958	852960
PUMP RATIO (NOMINAL)		1 x 1	
MATERIAL CONNECTION	SUCTION PORT	—	R 1-1/2
	DISCHARGE PORT	Rc 3/4	
AIR CONNECTION	SUPPLY PORT	Rc 1/4	
OPERATING AIR PRESSURE		0.3 ~ 0.7 MPa	
MAXIMUM OPERATING NOISE	A-WEIGHTED SOUND PRESSURE LEVEL *1	91 dB	
	A-WEIGHTED SOUND POWER LEVEL *2	97 dB	
AMB. TEMP. RANGE	ENV. TEMPERATURE	0 ~ 60 °C	
	MATERIAL TEMP.	0 ~ 80 °C	
STROKE (NOMINAL)		70 mm	
DISCHARGE VOLUME per CYCLE *3		126 mL	
MAXIMUM DISCHARGE PRESSURE		0.7 MPa	
WEIGHT		5.0 kg	2.6 kg

*1 Measurement method of A-weighted sound pressure level is based on ISO 1996.

*2 Measurement method of A-weighted sound power level is based on ISO 3744.

*3 Discharge volume (per cycle) varies according to use conditions.

■ Performance Curve

NOTE

The continuous pump operation should be avoided if the desired delivery is in the range shaded in the figure below.

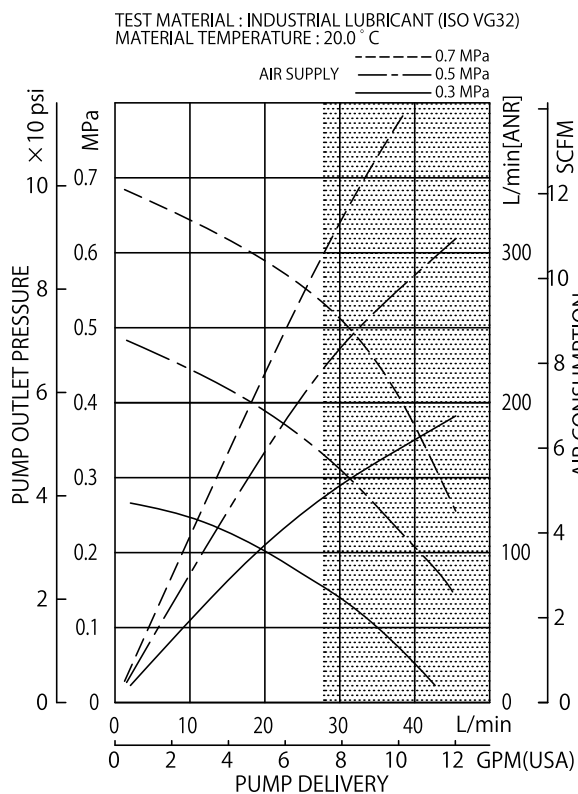

■ Dimensions

DR-50A1(852958)

SH-50A1(852960)

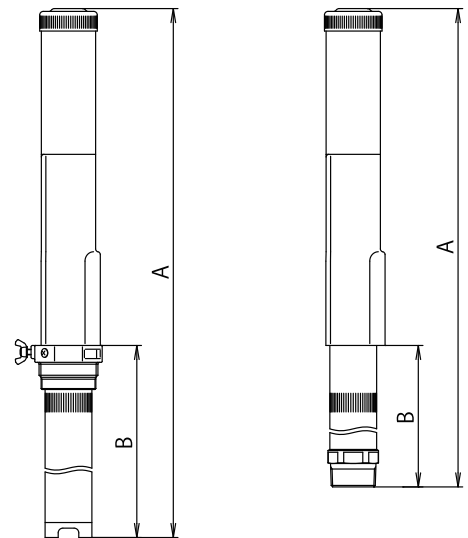

Model No.	A (mm)	B (mm)
852958	1270	910
852960	561	201

10. Accessory for SH-50A1 (852960)

■ Panel unit (851837)

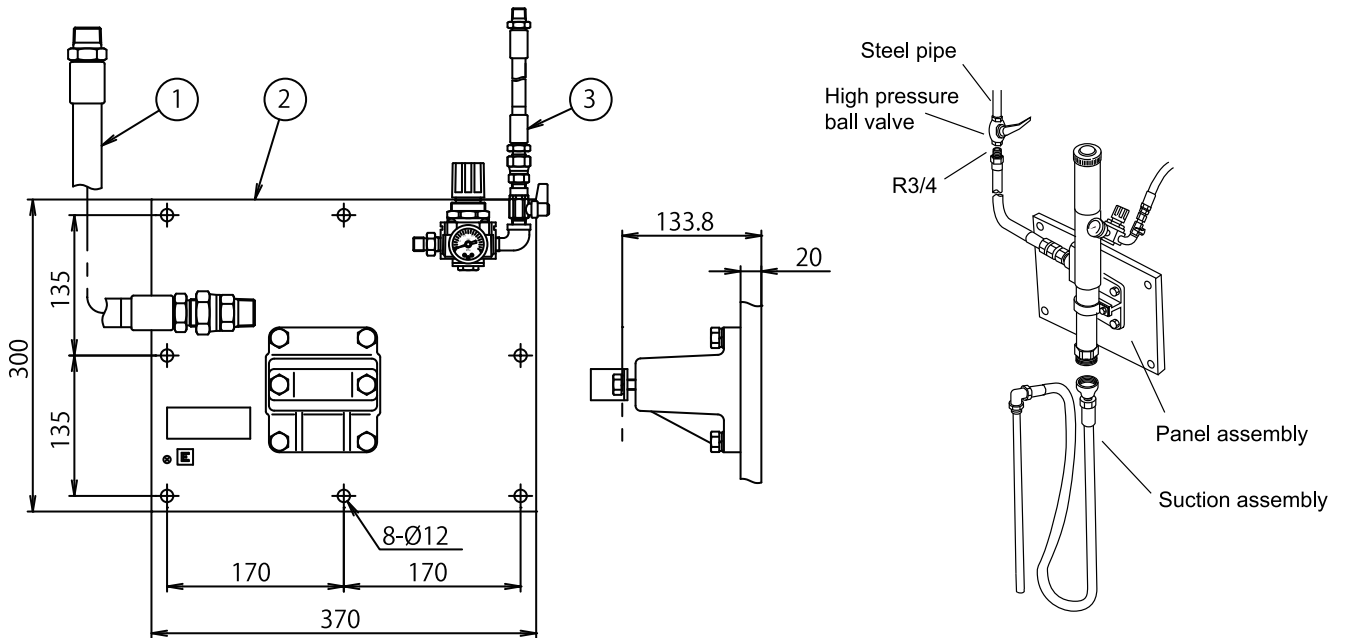

No.	Parts No.	Descriptions	Q'ty
1	801102	Delivery hose assembly	1
2	802557	Panel assembly	1
3	802558	Air regulator assembly	1

■ Suction assembly (850126)

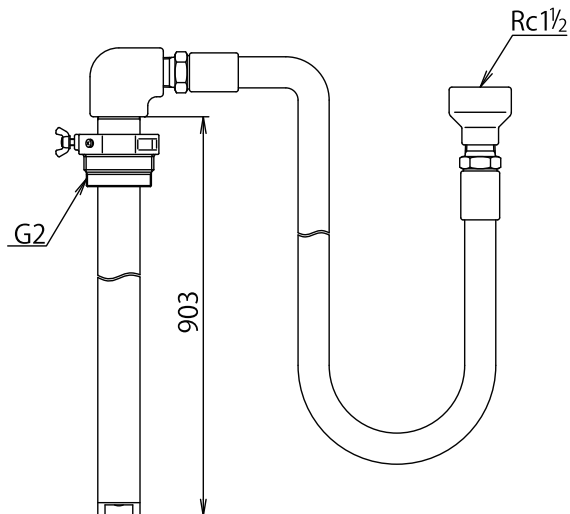

11. Limited Warranty

- If an abnormality occurs during normal operation in accordance with the operating instructions and other operating cautions within the warranty period (12 months after date of purchase) that can be attributed to a manufacturing defect, the defective parts of this product will be serviced or the product will be replaced free of charge. However, this warranty will not cover compensation for incidental damage or any malfunction listed below.

1. Warranty period

This warranty will be valid for a period of 12 months after the date of purchase.

2. Warranty

If, during the warranty period, any of the material of the genuine parts of this product or the workmanship of this product is found defective, and is so verified by our company, the servicing cost will be fully born by our company.

3. Exclusion

Even during the warranty period, this warranty does not cover the following:

- 1) Malfunction arising from use of parts other than manufacturer-specified genuine parts
- 2) Malfunction arising from misuse or operating errors, or lack of storage or maintenance care
- 3) Malfunction arising from use with a fluid that may cause corrosion, inflation or dissolution of the component parts of the product
- 4) Irregularity arising from repair made by other than by our firm, our regional office, dealer or authorized service personnel
- 5) Malfunction arising from modification of the product by other than authorized service personnel
- 6) Wear and tear of parts that must be regularly replaced in the course of normal operation, such as packings, O-rings, balls, and valve seats
- 7) Malfunction and/or damage due to transportation, moving or droppage of the product after purchase
- 8) Malfunction and/or damage due to fire, earthquake, flood or other force majeure
- 9) Malfunction arising from use of compressed air that contains impurities or excessive moisture, or use of gases or fluids other than the specified compressed air
- 10) Malfunction arising from use with a fluid that causes excessive abrasion or use of lubricating oil other than that specified for this product

Furthermore, this warranty does not cover the rubber parts, or other parts that are subject to wear in normal operation, used in this product and its accessories.

4. Parts

Parts for this product will be kept available for 5 years after discontinuation of production. Once 5 years have elapsed after close of production, availability of parts for this product cannot be guaranteed.

MEMO.

Manufactured by
YAMADA CORPORATION

INTERNATIONAL DEPARTMENT

No.1-3, 1-Chome, Mimami-Magome, Ohta-Ku, Tokyo, 143-8504, Japan

PHONE : +81-(0)3-3777-0241

FAX : +81-(0)3-3777-0584

YAMADA EUROPE B.V.

Aquamarijnstraat 50, 7554 NS Hengelo (0), The Netherlands

PHONE : 31(0) 74-2422032

FAX : 31(0) 74-2421055